

**WINMAN A,B Serisi Şartlandırıcı Grupları / A,B Series Preparation Unit**

**AR, BR Serisi Regülatör / AR, BR Series Regulator**



**Özellikler / Specification**

Model	AR1500	AR2000	BR2000	BR3000	BR4000
Fluid	Air				
Port size [Note1]	1/8"	1/4"	1/4"	3/8"	1/2"
Pressure range	0.05~0.9MPa(7~130Psi)				
Max. Pressure	1.0MPa(145Psi)				
Proof pressure	1.5MPa(215Psi)				
Temperature range	-20~70°C				
Weight	200g			230g	

[Note1] PT thread, G thread and NPT thread are available.

**Sembol / Symbol**

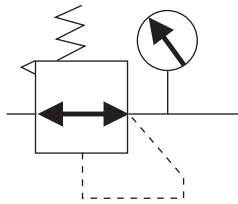

**Üretim Özelliği / Production Feature**

1. The structure is delicate and compact, which is convenient for installation and application.
2. The pressed-in self-locking mechanism can prevent the abnormal movement of the set pressure caused by external interfere.
3. In addition to standard type, lower pressure type is optional (The highest adjustable pressure is 0.4MPa).

**Sipariş Kodu / Ordering Code**

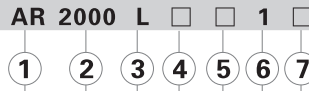

① Model	② Port size	③ Type code	④ Accessories	⑤ Pressure gauge	⑥ Scale	⑦ Thread type
AR: A Series Regulator	1500: 1/8" 2000: 1/4"	Blank: Standard (0.9MPa)	Blank: Bracket J: No bracket	Blank: Pressure gauge N: No pressure gauge	1: MPa 2: psi 3: bar 4: kgf/cm <sup>2</sup> & psi	Blank: PT (Scale: Mpa or kgf/cm <sup>2</sup> & psi) G: G(Scale:bar) T: NPT(Scale:psi)
BR: B Series Regulator	2000: 1/4" 3000: 3/8" 4000: 1/2"	L: Lower pressure (0.4MPa)				

**İç Yapısı / Inner structure**

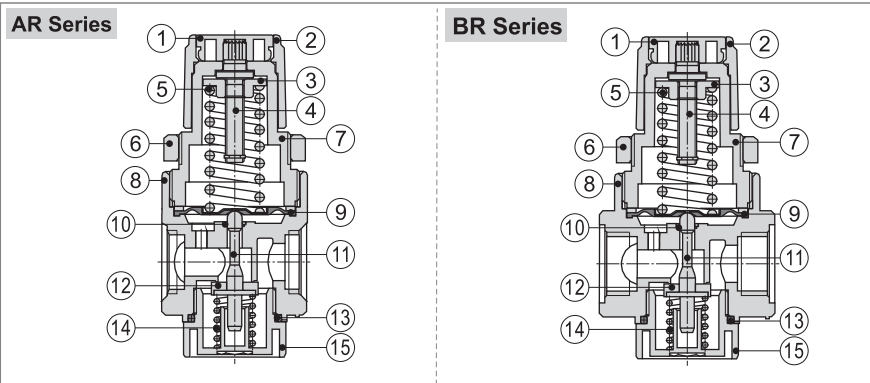

No.	Item	Material
1	Push button	POM
2	Adjusting button	POM
3	Adjusting nut	Steel
4	Adjusting pillar	Steel
5	Adjusting spring	SWC
6	Fixed ring	POM
7	Adjusting seat	POM
8	Body	Aluminum alloy
9	Diaphragm	SUS304 & rubber
10	Needle O-ring	NBR
11	Balance needle	POM
12	Needle gasket	Aluminum alloy & rubber
13	Cap O-ring	NBR
14	Return spring	Stainless steel
15	Regulator cap	POM

**WINMAN A,B Serisi Şartlandırıcı Grupları / A,B Series Preparation Unit**

AR, BR Serisi Regülatör / AR, BR Series Regulator

Basıncı ve özellik akışı / Pressure and feature flow

**Pressure chart**

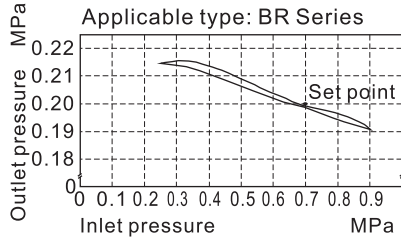
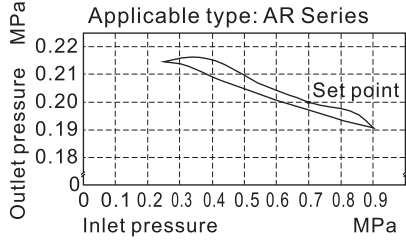

**Flow chart**

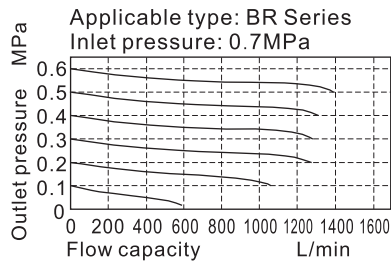
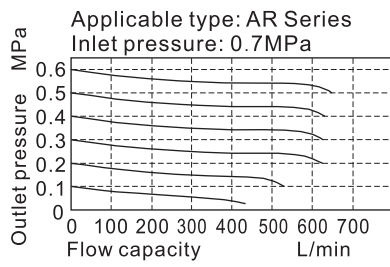

**Boyutlar / Dimensions**

**AR Series**

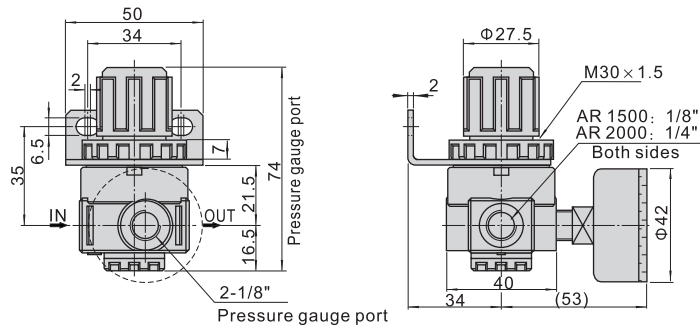

**BR Series**

