

WINMAN İtme-Çekme Valfi (3/2 Yollu) / Push-pull valve (3/2 way)

3L Series

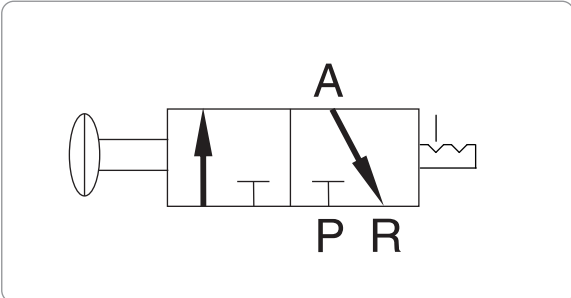

Symbol



Flow chart

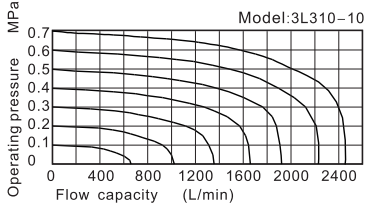
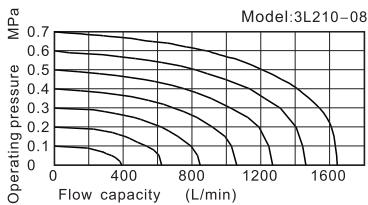
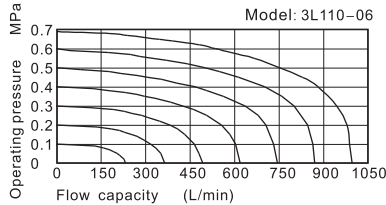

Inner structure

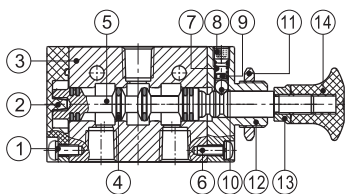

No.	Item	No.	Item	No.	Item
1	Round head screw	6	Round head screw	11	Hexagon nut
2	Bottom cover	7	Spring	12	Top cover
3	Body	8	Stop screw	13	Safety nut
4	O-ring	9	Spring base	14	Hand grip
5	Spool	10	Steel ball		

Specification

Model	3L110-06	3L210-06	3L210-08	3L310-08	3L310-10
Fluid	Air(to be filtered by 40 μ m filter element)				
Operating	Manual control direct acting type				
Port size ①	1/8"		1/4"		3/8"
Orifice size	12.0mm ² (Cv=0.67)	14.0mm ² (Cv=0.78)	16.0mm ² (Cv=0.89)	25.0mm ² (Cv=1.39)	30.0mm ² (Cv=1.67)
Valve type	3/2 Way				
Lubrication ②	Not required				
Pressure range	0~1.0 MPa (0~145 psi)				
Proof pressure	1.5MPa(215 psi)				
Temperature	-20~70 °C				
Material body	Aluminum alloy				

[Note1] PT thread, G thread and NPT thread are available;

[Note2] Once lubricated air is used, continue with same medium to optimise valve life span. It is suggested to use ISO VG32 lubricant or the oil with the same grade.

Ordering Code

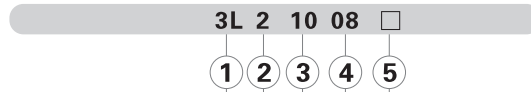

① Model	② Code	③ Valve type	④ Port size	⑤ Thread type
3L: 3 port 2 position push-pull valve	1: 100 Series	10: 2 position	06: 1/8"	Blank: PT G: G T: NPT
	2: 200 Series		06: 1/8" 08: 1/4"	
	3: 300 Series		08: 1/4" 10: 3/8"	

Dimensions

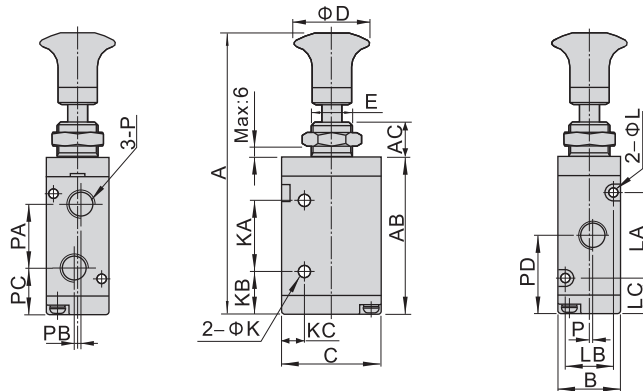

Item\Model	3L11006	3L21006	3L21008	3L31008	3L31010
A	87	98	98	106.5	106.5
AB	47.8	57.8	57.8	66.5	66.5
AC	10	10	10	10	10
B	18	22	22	27	27
C	27	35	35	40	40
D	25	25	25	25	25
E	M12×0.75	M14×1.0	M14×1.0	M16×1.0	M16×1.0
K	3.1	4.3	4.3	4.3	4.3
KA	21	25	25	30	30
KB	13	16	16	18	18
KC	7.7	8	8	10	10
L	3.3	3.3	3.3	4.3	4.3
LA	19	30	30	35	35
LB	13	17	17	20	20
LC	14	13.5	13.5	15.5	15.5
P	1/8"	1/8"	1/4"	1/4"	3/8"
PA	16	22.5	22.5	24	24
PB	2	0	0	0	0
PC	15.5	17.5	17.5	21	21
PD	24.5	28.5	28.5	33	33
PE	1	0	1.5	0	2