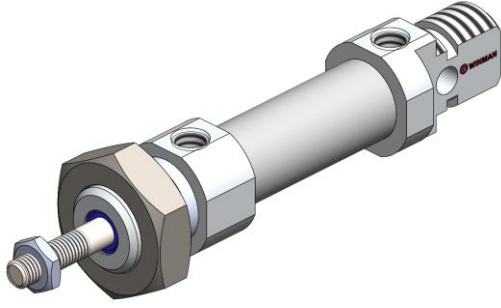
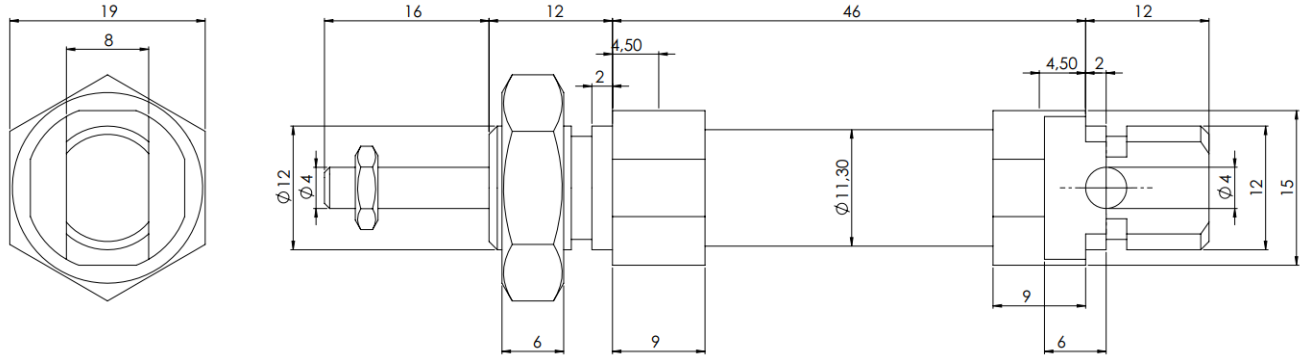

WSSC 010 - Serisi ISO 6432 Silindirler / WSSC 010 - Series ISO 6432 Cylinders

Özellikler / Specification

Piston Çapı / Bore Size	10
Çalışma Tipi / Acting Type	Çift Etkili / Double Acting
Akışkan / Fluid	Hava (40µm filtrelenmiş) / Air (40µm filtered)
Çalışma Basıncı / Op. Pressure	< 10 Bar
Sıcaklık / Temperature	0 ~ +80 °C
Manyetik / Magnetic	Opsiyonel / Optional
Hız / Speed Range	< 800 mm/s
Sensör / Sensör Switches	WT-05/WT-15 + BK81

Teknik Çizim / Technical Drawing

Sipariş Kodu / Ordering Code

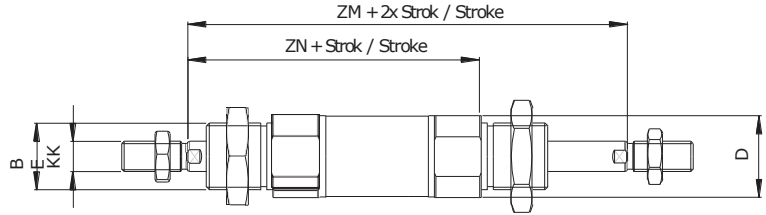
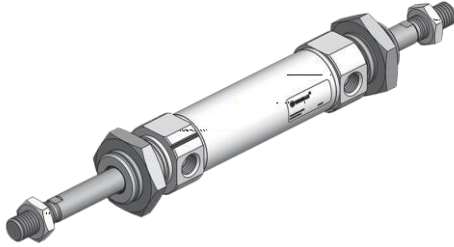
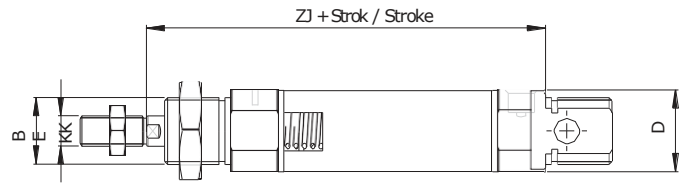
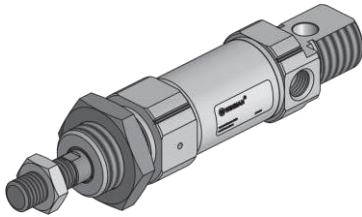
MODEL	OPSİYON OPTIONS	MANYETİK MAGNETIC	YASTIKLAMA CUSHONING	ÇAP DIA.	STROK STROKE	MİL UZUNLUĞU ROD LENGHT	DIŞ TİPİ SCREW TYPE	DIŞ ÖLÇÜSÜ SCREW SIZE	DIŞ UZUNLUĞU SCREW LENGHT
WSSC	D	M	YY	010	0050	L25	F	ZM8.H1.0	E15

BOŞ: STANDART D : ÇİFT MİLLİ J : STROK AYARLI HR: DÖNMEZ MİLLİ FS : ÖNDEN YAYLI (50mm ye Kadar) RS : ARKADAN YAYLI (50mm ye Kadar) V : SICAĞA DAYANIKLI 150° Sıcaklığa Kadar	- Blank Standart - Double Rod - Stroke Adjustable - Hegzagonal Roc - Front Spring (Up to 50mm) - Rear Spring (Up to 50mm) - Heat Resistance (Up to 150°C)	BOŞ :MANYETİKSİZ Blank :Without Magnet M :MANYETİK M :With Magnet	BOŞ :YASTIKSIZ Blank :Uncushioned YY :YASTIKLI YY :Cushinoed	PISTON ÇAPI (mm) Piston Dia	STROK (mm) Stroke	LX (mm) - BOŞ :STANDART Blank :Standart	F :DIŞİ Female BOŞ :STANDART Blank :Standart	Zx :ÇAP Dia Hx :Hatve Pitch BOŞ :STANDART Blank :Standart	Ex (mm) BOŞ :STANDART Blank :Standart

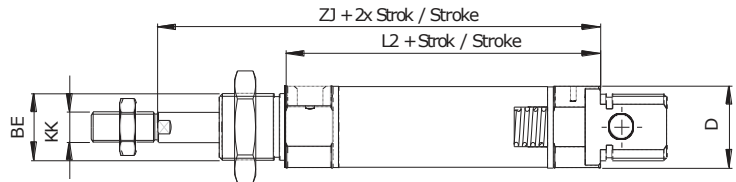
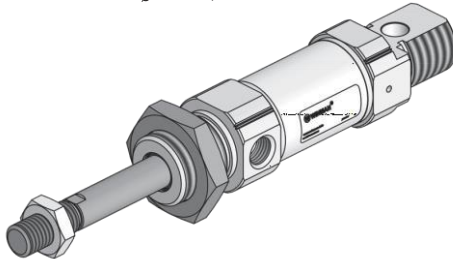
WSSC - Serisi ISO 6432 Silindirler / WSSC - Series ISO 6432 Cylinders
Çift Milli Silindirler / Trough Rod Cylinders
WSSC.M.YY.010.0050.D
Ø Strok / Stroke

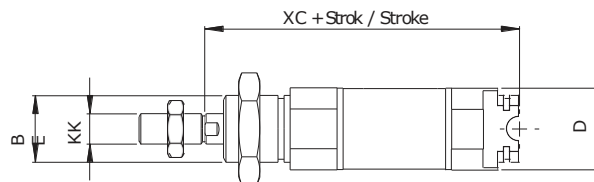
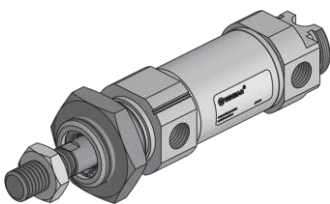
Önden Yaylı Silindirler / Single Act. Front Spring Cylinders
WSSC.M.YY.010.0050.FY
Ø Strok / Stroke

 50 mm kurs üzeri için bilgi alınız.
 Contact us above 50 mm stroke

Arkadan Yaylı Silindirler / Rear Spring Cylinders
WSSC.M.YY.010.0050.RY
Ø Strok / Stroke

 50 mm kurs üzeri için bilgi alınız.
 Contact us above 50 mm stroke

Kısaltılmış Silindirler / Short Cap Cylinders
WSSC.M.YY.010.0050.K3
Ø Strok / Stroke

Ø mm	ZM	ZN	ZJ	L2	XC ±1	BE	KK	D Ø
10	78	62	62	46	64	M12X1.25	M4X0.70	16